

java

Assembly Instructions

airline
FOLDING SIT-ON-TOP KAYAKS

by Feathercraft

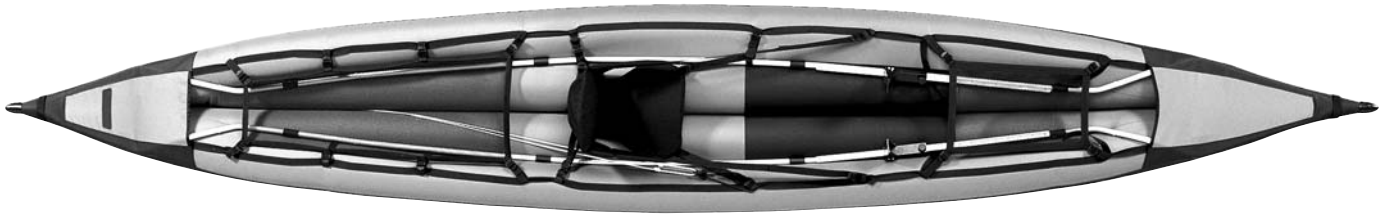

Contents

- 1 Kayaking Safety**
- 3 Care and Maintenance**
 - Repairing or Replacing Air Tubes**
- 4 Java Assembly Instructions**
- 10 Java in Double Configuration**
- 14 Frequently Asked Questions**

Kayaking Safety

PLEASE READ CAREFULLY!

Kayaking can be hazardous and can involve the risk of serious injury or death. Kayakers are responsible for obtaining appropriate instruction in paddling skills, equipment safety, water safety, rescue and first aid. It is strongly recommended that you obtain training in kayaking safety from a qualified and experienced kayaking instructor.

The various components of Feathercraft kayaks are subject to wear, breakage and failure. This type of damage can lead to accidents resulting in serious injury or death. It is your responsibility to maintain your kayak in excellent condition. Disassemble your kayak completely at least every two months. Re-lubricate the framework and inspect for signs of wear or failure. Any worn, damaged or broken parts must be repaired or replaced. If you have any doubts or concerns about the condition of your Feathercraft kayak, contact your dealer or Feathercraft Products Ltd.

Kayak safety training should include the following topics:

1. **Paddling skills.** Paddling techniques need to be practiced in various water conditions. Maneuvering a kayak through rough seas, currents and tidal zones is quite different from paddling on flat water.
2. **Hypothermia.** The greatest danger to a kayaker is hypothermia or cold water immersion. Protection against hypothermia involves more than simply wearing the appropriate protective clothing. It involves all aspects of kayak safety.
3. **Know Your Kayak.** Your safety on the water is dependant on all components of your kayak functioning perfectly. You must inspect your kayak for signs of wear or failure before setting off on every trip, including seams, hatches, spray skirt, rudder and hull.
4. **Spray Skirt and Safety Sock.** All Feathercraft kayaks come equipped with a spray skirt and safety sock (except the Klondike, where the socks are optional, and the Air Line Sit-on-Top models). These are important safety items, but you must be fully familiar with their use before an emergency arises.

5. **Personal Flotation Device and Helmet.** The wearing of an approved PFD is highly recommended for all kayakers, even those who are strong swimmers. A helmet should be worn for whitewater or surf zone paddling.
6. **Safety Equipment.** The safety equipment you will carry in and on your kayak will vary with the nature and length of the trip. Kayak trips of any duration however, require a pump, spare paddle, bouyant heaving line, flares and whistle as essential items. Safety equipment will only be of use to you if you have the knowledge and training to use the equipment in an emergency.
7. **Self-Rescue and Group Rescue.** The nature of kayaking is such that some day you or a member of your group will capsize. This experience can vary from a refreshing dip in the ocean to a life-threatening emergency. How you handle a capsize will depend entirely on your training and experience.

The kayaking community is blessed with a wealth of material, including books, manuals, magazines, articles and videos, and resources including schools, clubs, associations and training centres dedicated to kayaking safety. As with any skill, kayaking safety must first be learned and then practiced. We at Feathercraft strongly recommend that you access resources for kayak safety in your community before venturing out onto the water.

For more information on kayaking safety, please contact your local kayak dealer, or your kayak or canoe association. These websites will get you started.

University of Sea Kayaking
→ www.useakayak.org

Trade Association of Paddlesports
→ www.gopaddle.org

Sea Kayaker Magazine
→ www.seakayakermag.com

Care and Maintenance

Avoid mildew damage — do not store the skin wet.

When the kayak is taken apart for storage, thoroughly clean all frame tubes with fresh water. Re-apply Bo-Shield T-9 to all frame parts, making sure to well lubricate the telescoping sections and the spring buttons. This should be done at least once a month, possibly more, depending on the salt concentration in the water you are paddling.

A Note on Disassembly

Always lubricate framework. However, after extended use in surf and sand, the frame parts may be difficult to disengage. As shown in the illustration below, open the “twist-assist” on the aluminum tubing, and insert screw drivers to twist the tubes apart. The keel hinge pin can also be substituted for one of the twisting tools.

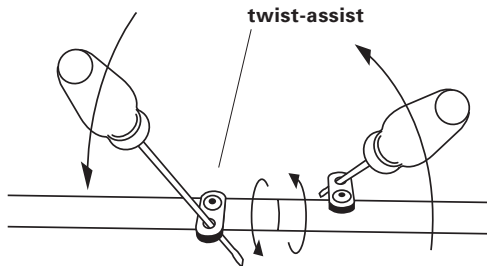

Repairing or Replacing Air Tubes

To access the chamber for the air tube, turn the bow and stern ends “inside out”. Hidden here is a Velcro opening to access the air tube. Before pulling the air tube out — tie a long string to the opposite end from where the air nozzle is. Pull the air tube out, threading the string through the chamber. This string will be used to feed the new or repaired air tube back through the chamber.

Aqua Seal is used to repair holes or punctures of either the air tubes or the hull. Follow the preparation instructions as outlined on the Aqua Seal containers. Use the popsicle stick to mix and apply the Aqua Seal. Secure the patched area with duct tape. Applying weight to a patched area is also helpful (i.e. bag of sand). To make a quick repair with duct tape, first swab the area with rubbing alcohol or Cotel 240 Accelerator.

When re-inserting the air tube, check that the air tube does not get twisted in the chamber. If you should need to replace an air tube, be sure to request by the color on the nozzle (Yellow, Red, Green or Blue).

Java Assembly Instructions

1. Frame parts

Using rubber gloves, liberally lubricate frame inserts with Bo-Shield T-9.

Stern Section

keel bar

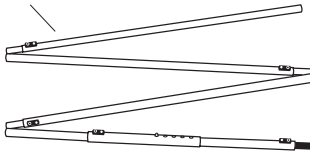

drop skeg

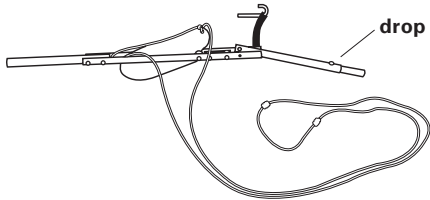

gunwales

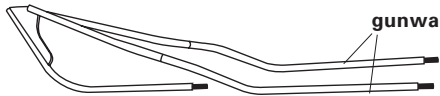

Bow Section

gunwale bar with foot track

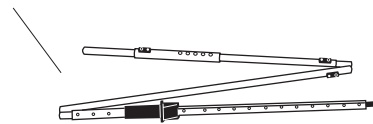

gunwales

keel

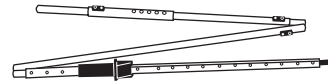
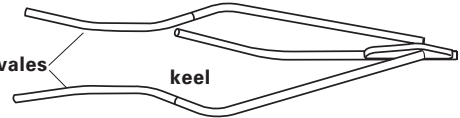

2. Roll out skin

Insert frame section stamped "B" into the bow of the skin.
Insert frame section stamped "S" into the stern of the skin.

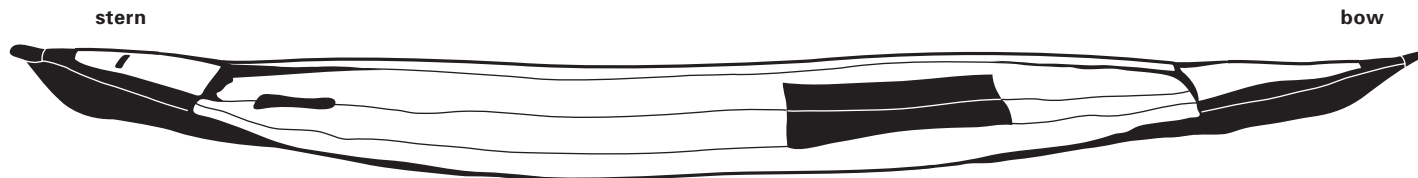

Center the keel end pieces.

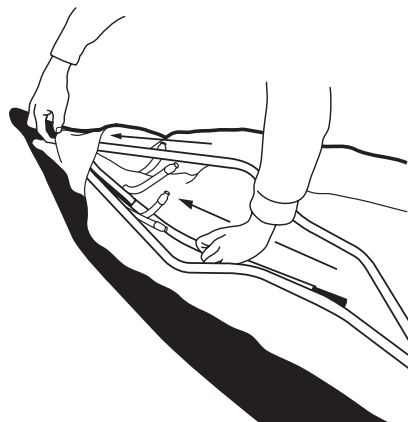

3. Attach keel bar

Attach skieg to the shockcorded keel sections. The keel and gunwale frame sections have telescoping tubing that can be adjusted for fit. The usual positioning for the spring button is in the center hole.

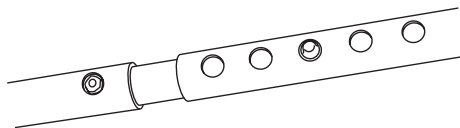

a) The drop skieg is positioned towards the stern. Attach the keel bar to the keel of the bow frame assembly. The keel hinges up, and joins to the keel of the stern keel assembly. **b)** Push keel hinge down. Lock in place with hinge pin. The keel bar will be “snaked” or curved quite substantially — this is what should happen. Pull the keel bar to the center of the skin and secure with the Velcro straps.

Center the drop skieg over slot in hull.

Attach the haul cord for the drop skieg to the bungee cord with hook tied to webbing.

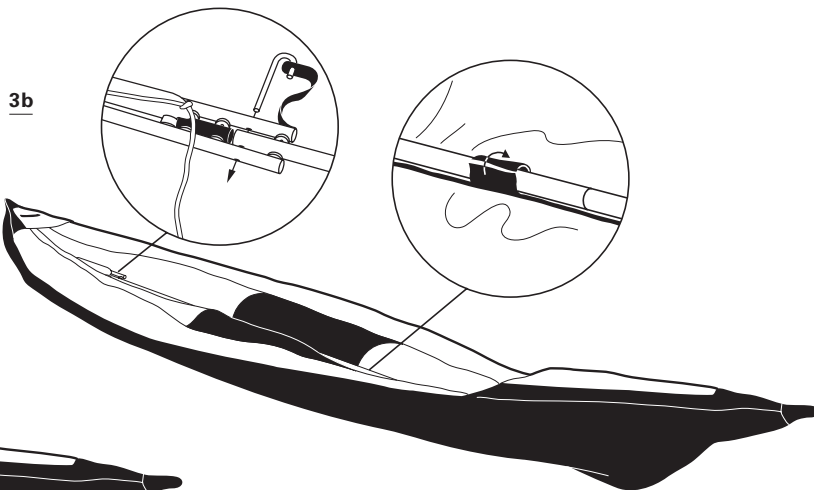
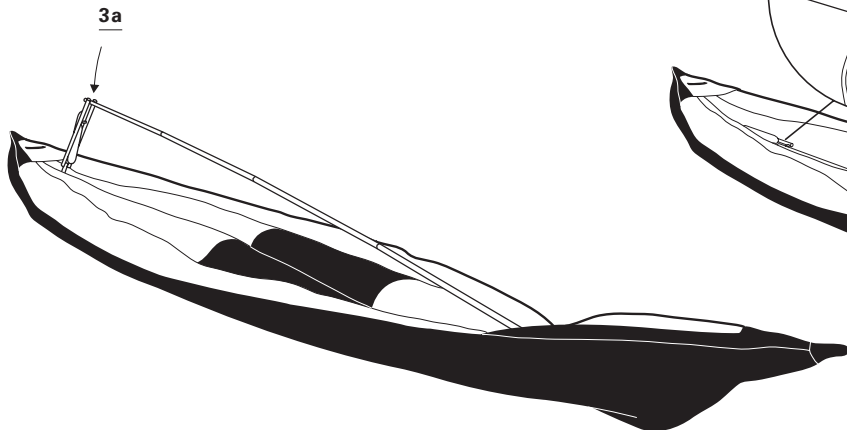

4. Attach gunwale bars

The two gunwale bars are the same. The bow end has the foot track. Set the telescoping tubes on the gunwales to the same spring button position as the keel.

Attach stern end of gunwale bar to curved stern gunwale section.

Rotate tube "up" and attach the bow end (with foot track) to curved bow gunwale bar.

As you kneel at the bow, twist tube "down" towards the skin, and secure with Velcro straps. Repeat at stern.

Follow these same steps for the opposite side.

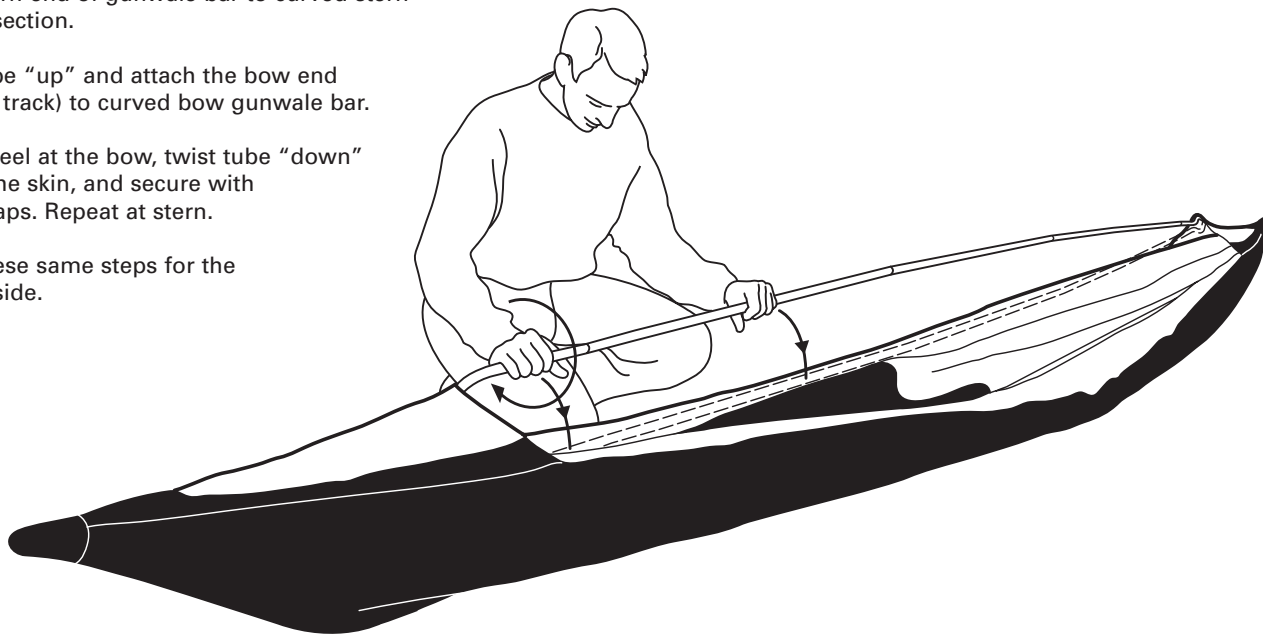

5. Inflate air chambers

a. Before beginning to inflate, position the seat approximately mid-ships. Slide the seat side straps under the gunwale tubes and attach to the tension lock on seat wing.

b. Begin by partially inflating the Yellow and Blue air chambers, followed by the Red and Green.

Complete by fully inflating all air chambers until firm (not hard). In hot conditions, inflate slightly less.

To allow the paddler to sit lower, Yellow and Blue chambers can be less firm.

5b

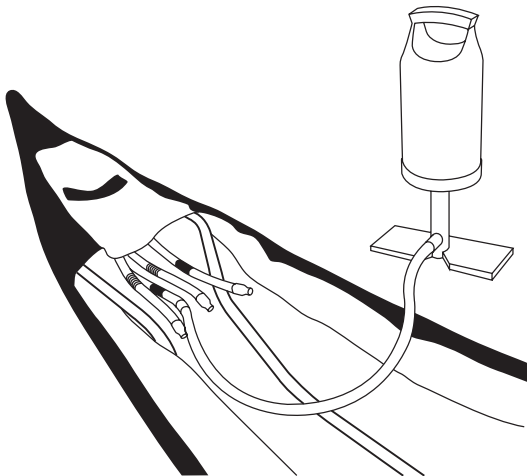

5a

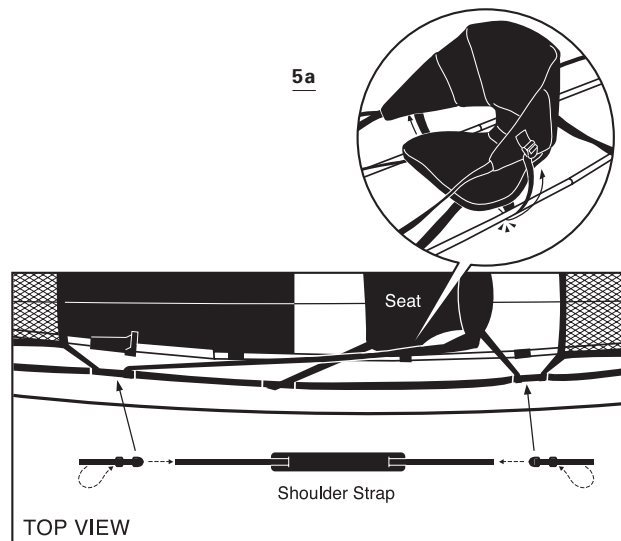

5c

c. Attach shoulder strap/thigh brace. The strap from the carrying bag can be attached to the tension locks on the deck webbing. A second strap with attachment buckles is included.

6. Complete installation of seat

Seat is attached to buckles with grey webbing at position 3, 4 and 6 (see schematic below)
Thigh/carrying straps are attached to black web loops at position 3 and 6. (second thigh strap is carry-bag strap)

There is a web strap sewn to the inside channel of the keel. To keep the seat from sliding forward, connect the strap to the buckle on the underside of the seat.

7. Install deck mesh

Straps for mesh go through the "gaps" in the webbing sewn along the deck.

Web loop colours:



bow

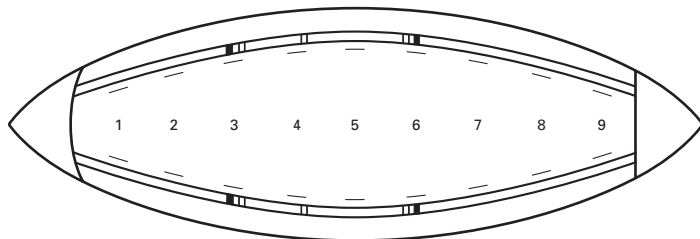

IMPORTANT

To avoid ripping the webbing from the deck fabric, always attach mesh decks, seats and shoulder straps through the two-tone loops.

Note: Foot braces are oriented with screw heads facing in towards the center of the kayak to avoid abrasion.

stern

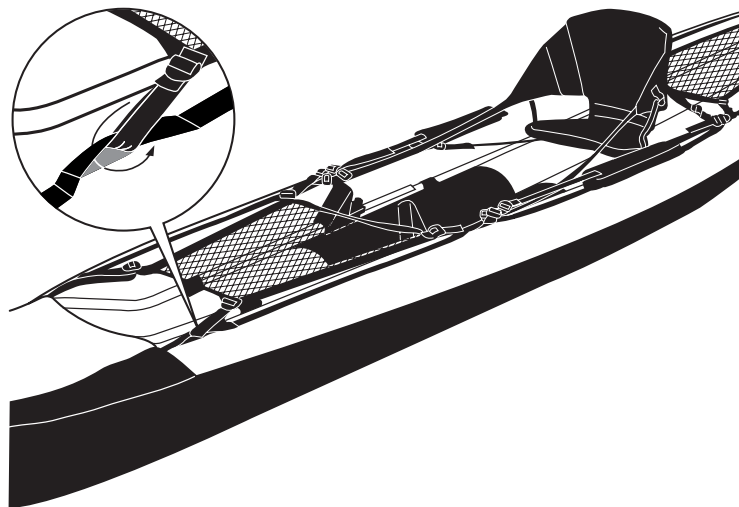

Over-View of Java in Double Configuration

Options for Double Configuration (shown)

- Second seat and foot brace.
- Rudder with cables and adjusters. We recommend the rudder for use with Java as a double.

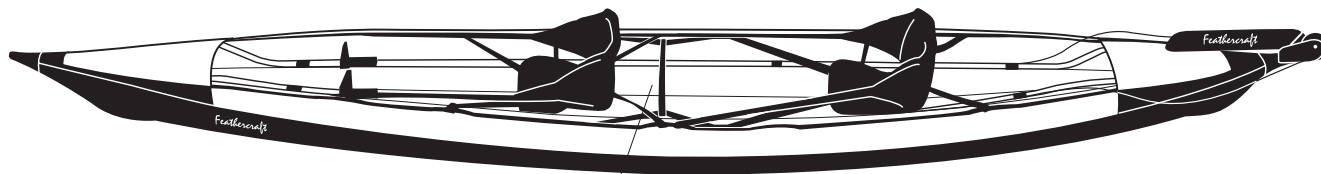

stern foot brace

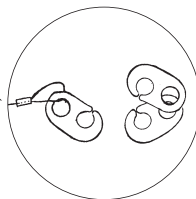
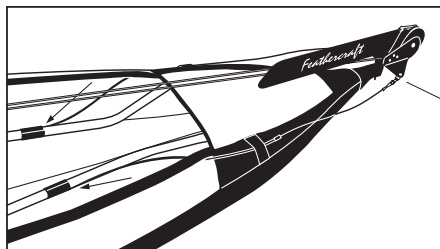

Sister Clips (two of these clips are mounted on each side of the rudder).

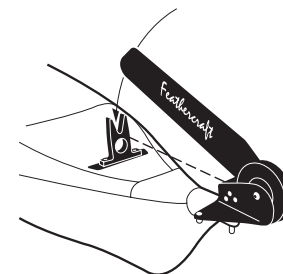

Mark placement of V-block on black reinforcement strip. Install with rivets or nuts and bolts.

When using the rudder, run the cables under the deck webbing, and through the gunwale velcro closures to the bow foot braces.

Java in Double Configuration cont'd

Numbers indicate attachment points.
 All attachments are to be made through the
 two-tone webbing. See diagram page 7.

Double seat configuration with:

- 2 pairs thigh straps
- 1 aft foot brace

Web loop colours: black web #5 T-buckle grey web

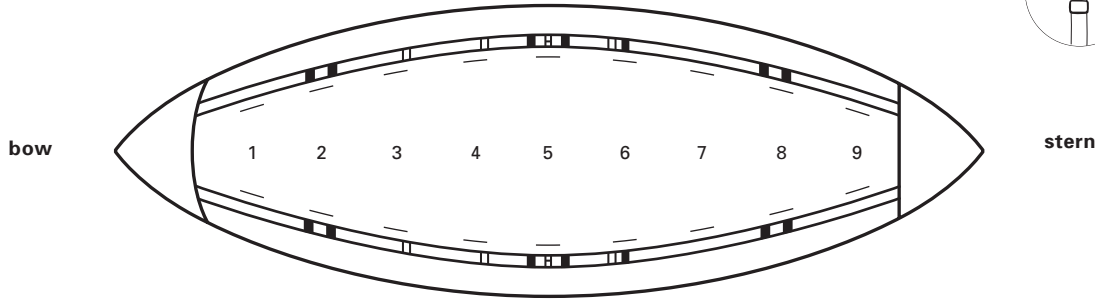
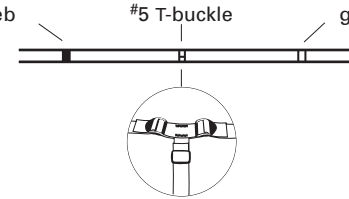

- | | | | |
|-----------------------------|-------------|-------------|----------|
| Forward Seat | #2 black | #3 grey | #5 black |
| Aft Seat | #5 black | #6 black | #8 black |
| Aft Foot Brace | #4 grey | #6 grey | |
| Forward Thigh Straps | #2 black | #5 T-buckle | |
| Aft Thigh Straps | #5 T-buckle | #8 black | |

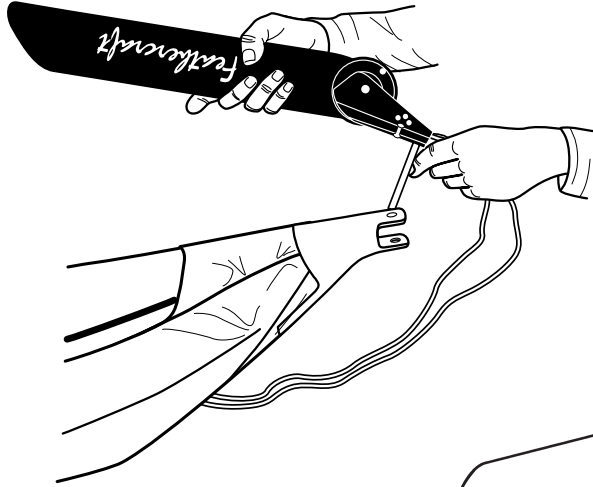

Install Rudder

Insert the rudder pin through the "key hole".
Rotate rudder 180°.

Attach rudder cables with sister clips. White haulcord is attached to clip beside seat.

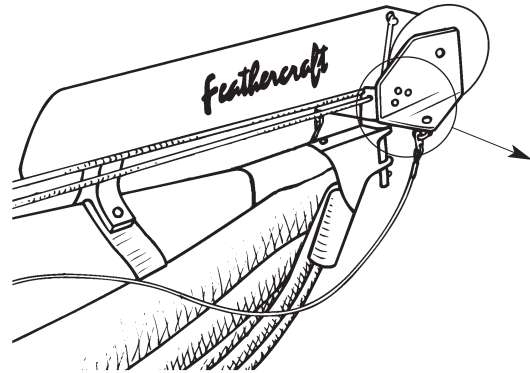

Connecting Rudder Control to Bow Foot Brace

Webbing adjusters are connected to the foot brace. Unscrew thumb-knob on foot brace; stem of knob goes through grommet. Re-attach knob to foot brace. Slide brace on to track. Ensure brace can slide easily on track. (If not, check knob that you re-attached.)

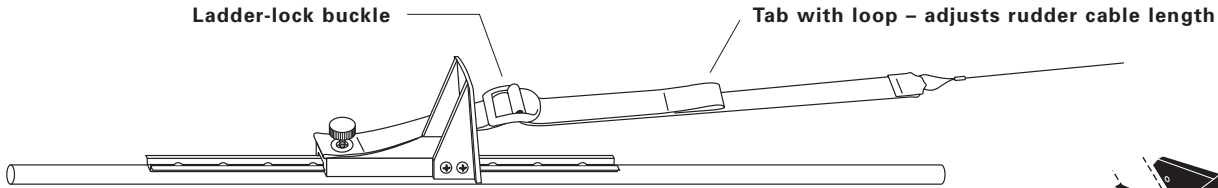
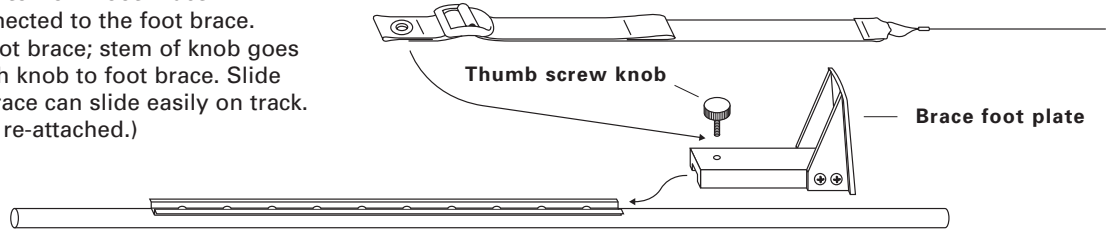

Note: If additional leg extension is required for the bow paddler, the brace foot plate can be reversed by unscrewing the nuts and bolts at the base. This has already been done if the Java was ordered with the 2nd seat option.

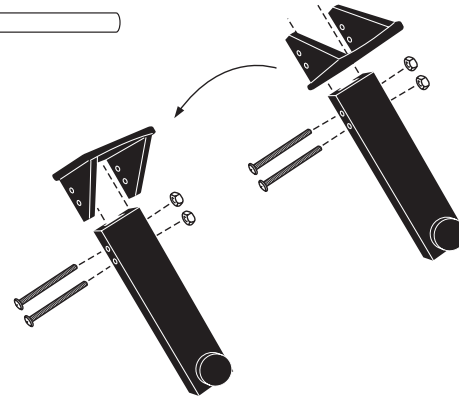

Frequently Asked Questions

The following are general “Frequently Asked Questions” about Feathercraft kayaks.

What is the Warranty ?

All Feathercraft Kayaks come with a five year warranty on all parts and workmanship. Our service and support will continue well after that, as your Feathercraft Kayak is expected to last 10 to 15 years.

The best advertising available is a happy kayaker paddling their Feathercraft!

Materials and Construction

The Hull

For years we used hypalon. This was the best product available. Hypalon is a rubber and neoprene laminate that is extremely rugged and durable. To make a hull of hypalon fabric various glues and chemical compounds are required to bond the sections together. It is a toxic, incredibly labour intensive job. Huge developments have been made in the fabric industry in recent years. And now other fabric options have become available.

All fabric hull material begins with a cloth weave of either polyester or nylon. Then the fabric is coated with either polyvinyl chloride (PVC vinyl), urethane or hypalon. The best cloth weave is made of high-tenacity fibers woven in a tight, balanced weave (i.e. a similar number of threads going both lengthwise and across the fabric).

Urethane is harder than hypalon rubber and much harder than PVC, hence having higher abrasion resistance. Urethane coated fabrics have typically been used as heavy duty truck and equipment tarps and on inflatable rafts. We found that these massed produced, single coated fabrics are too stiff to stretch over our sleek frame works. We had to work with our supplier to develop the combination of strength and suppleness that we require. The base fabric is made from high tenacity nylon fibers, an 840 denier balanced weave. The fabric is scorched (heated) and dyed. To ensure high adhesion of the coating to the fabric, a solution coat of thin urethane is impregnated into the fibers. This is followed by successive applications of urethane coats. The outer coats are harder than the inner coats. The fabric is extremely tough, yet supple. The advantages are obvious: high abrasion resistance, high UV resistance, resistant to fading, supple, light weight, weldable. The disadvantage is that this fabric, which is made in small quantities for Feathercraft, is considerably more expensive than hypalon.

Different Hull Fabrics are Used by Different Manufacturers.

a) PVC This material may seem quite robust because of its cloth support. However, PVC (vinyl) is soft and abrades relatively easily. It has very poor UV resistance, and after a few years becomes quite brittle. Its main advantage is that it is inexpensive (about one quarter the cost of hypalon and Duratek). PVC can also be welded.

b) Urethane: This is a very hard and abrasion-resistant material. It is also considerably lighter than hypalon, and is more resistant to many toxic chemicals. Previously, we could not use urethane as a hull fabric because it was incredibly difficult to bond using traditional glueing methods. But we knew it could be welded, and that this was the direction we wanted to go. A special fabric was developed for us to use as a hull fabric. New equipment has also become available allowing us to create the complicated shapes and curves of our hulls.

c) Hypalon: This has traditionally been the standard for expedition-style skin kayaks. Hypalon is basically neoprene (a synthetic rubber) with additives patented and supplied by DuPont. These increase UV resistance and allow the material to be dyed. The best hypalon is still made in Europe. The type we used for years, came from France. We changed our hull fabric for two reasons: one, to get away from the toxic chemicals required to fabricate the hulls; and two, for our sit-in models, we wanted to weld a skin that would be completely sealed, water-tight and dry. Hypalon can not be welded.

How tough is the hull?

The hull is extremely durable. With some care, you should get 10 to 15 years of use. You should treat the craft with the same respect and care that you would a fiberglass hull. Try to avoid dragging it over rocks, or crashing it onto coral or barnacles. But don't worry, if it is unavoidable, it can take the abuse. (We just don't recommend it all the time.) The interesting thing with a skin hull, if you meet up with a solid object like a rock or chunk of coral, the fabric "gives", so the impact is not as intense. A fiberglass hull would just "crunch".

Can I repair the hull?

Patching the hull is similar to patching a bicycle tire. Aqua Seal can be used to fill small cosmetic nicks. To make a quick fix with duct tape, or one of the "Quick Patches", first clean the area with rubbing alcohol or Cotel. Patching instructions are detailed on the adhesive in the repair kit.

The Deck

The deck fabric is polyester with a light coating of urethane on the underside. Allow the skin to dry completely before rolling up for storage.

The Frame

The frame is made from 6061-T6, and 6063-T832 anodized magnesium/aluminum alloy, and is the strongest, yet lightest in weight. This same alloy is used extensively in the aircraft industry. We have had surprisingly few repairs, considering

the number of boats that we have sold. Tour operators tell us that they have far fewer repairs than with wood-frame kayaks. One of the many beauties of a folding kayak is that should a piece break or get lost, that single piece can be repaired or replaced.

The alloys that we use are very corrosion-resistant, and are used extensively in the marine industry. The clear anodized coating protects the aluminum from pitting. However, regular maintenance and lubrication are required to ensure that the sliding frame members do not seize together.

Framework Care & Maintenance:

1. Disassemble your kayak every two months.
2. Rinse the frame thoroughly with fresh water to wash off the sea salt and make assembling the frame much easier.
3. Lubricate joints, tubes, extension bars, and spring buttons with Bo-Shield T-9.
4. Let the skin dry completely on the frame before storing the kayak in its pack.

Repairs

A Standard Repair Kit is included with each kayak and contains:

1. written assembly instructions
2. Aqua Seal repair adhesive and Cotal accelerator
3. 1 oz dropper bottle of Bo-Shield T-9
4. sandpaper
5. 2 Quick Patches
6. patch fabric for deck, hull, sponsons, pack-bag

Preparation for glueing a patch to the Urethane hull :

1. Round the corners of your patch.
2. Ensure area is clean and dry.
3. Roughen smooth surfaces. Swab the area with Cotal.
4. For a two hour cure time, combine one part Cotal to three parts Aqua Seal.

5. As the adhesive itself is slippery, secure patched area with duct tape, and/or apply weight to the patch (ie, bag of sand). To apply a patch to the deck, ensure the fabric is clean and dry.

Sponsons

Sponsons are the air tubes that create your kayak. They are made from urethane and the seams are welded. Urethane is an extremely tough, yet light material. Each air tube is in a separate chamber.

Pre-caution:

If the kayak is not being paddled, but is in the sun during the heat of the day, release the air from the sponsons. Air in the sponsons will expand, and could potentially rupture the sponson.

The sponson can be repaired using the same technique and repair adhesive as the hull. To remove the sponson, turn the ends of the kayak skin inside out. The sponson chamber is accessible at either end. At the bow end of the sponson, there is a tab with a hole punched. Attach a long piece of string or rope to the end of the sponson. Disengage the air hose from the opposite end, and pull the sponson through the chamber. Once the repair has been made, pull the sponson back through the chamber with your rope. Be sure the sponson lies flat and does not get twisted.

Feathercraft Products Ltd.
4-1244 Cartwright Street on Granville Island,
Vancouver, British Columbia, Canada V6H 3R8
Telephone: (604) 681-8437 Fax: (604) 681-7282
www.Feathercraft.com info@feathercraft.com